

Local regulations may restrict the use of this product to below the conditions quoted.
 In the interests of development and improvement of the product, we reserve the right to change the specification without notice. © Copyright 2013



spirax sarco

TI-S02-26
ST Issue 7

FT14 Ball Float Steam Trap (Flanged)

Description

The FT14 is an SG iron bodied ball float steam trap having stainless steel working internals and integral automatic air venting facility. The FT14 can be maintained without disturbing the pipework.

Available types

FT14 (R-L) Horizontal connections with flow from right to left

FT14 (L-R) Horizontal connections with flow from left to right

Please note: On the cover of both of these traps, the orientation of the connections can be adjusted on site in preparation of downward vertical flow applications.

Capsule

The BP99/32 capsule which is used in the FT14 is suitable for use on 150°C superheat @ 0 bar g and 50°C superheat @ 32 bar g.

Optional extras

A **manually adjustable needle valve** (designated 'C' on the nomenclature i.e. **FT14-C**) can be fitted to the trap. This option provides a **steam lock release (SLR)** feature in addition to the standard air vent. For further information please consult Spirax Sarco.

The FT14 has the option of an **integral strainer screen** (designated 'X' on the nomenclature i.e. **FT14-X**).

Standards

This product fully complies with the requirements of the European Pressure Equipment Directive 97/23/EC.

Certification

This product is available with a manufacturers' Typical Test Report. **Note:** All certification /inspection requirements must be stated at the time of order placement.

Sizes and pipe connections

DN15, DN20 and DN25
 Flanged EN 1092 PN16, ASME 150 and JIS/KS 20.

Pressure/temperature limits (ISO 6552)

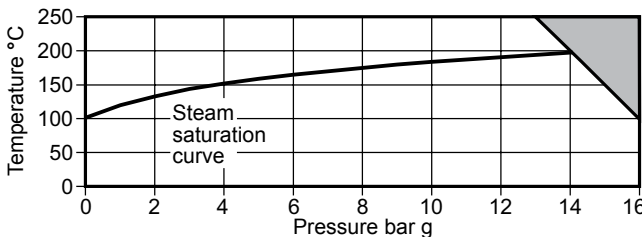

The product **must not** be used in this region.

Body design conditions		PN16
PMA	Maximum allowable pressure	16 bar g @ 100°C
TMA	Maximum allowable temperature	250°C @ 13 bar g
Minimum allowable temperature		-10°C
PMO		Maximum operating pressure for saturated steam service
		14 bar g
TMO	Maximum operating temperature	250°C @ 13 bar g
Minimum operating temperature		0 °C
	Maximum	FT14-4.5
ΔPMX	differential pressure	4.5 bar
		FT14-10
		10 bar
		FT14-14
		14 bar

Designed for a maximum cold hydraulic test pressure of 24 bar g

FT14-C (R-L)

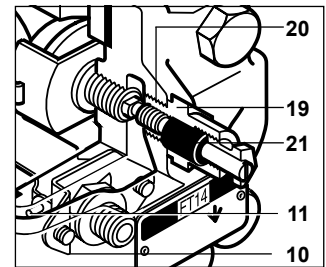

FT14 (R-L)

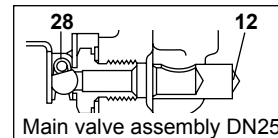
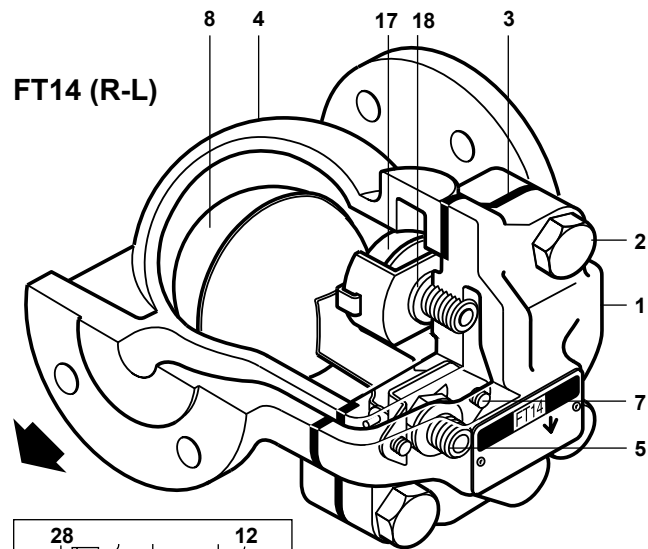

Materials

No.	Part	Material
* 1	Body	SG iron DIN 1693 GGG 40
2	Cover bolts	Steel BS 3692 Gr. 8.8
3	Cover gasket	Reinforced exfoliated graphite
4	Cover	SG iron DIN 1693 GGG 40
5	Valve seat	Stainless steel BS 970 431 S29
6	Valve seat gasket	Stainless steel BS 1449 409 S19
7	Pivot frame assembly screws	Stainless steel BS 6105 CI A2-70
8	Ball float and lever	Stainless steel BS 1449 304 S16
10	Pivot frame	Stainless steel BS 1449 304 S16
11	Pivot pin	Stainless steel
* 12	Erosion deflector (DN25 only)	Stainless steel BS 970 431 S29
17	Air vent assembly	Stainless steel BS 1449 304 S19
18	Air vent seat gasket	Stainless steel BS 1449 409 S19
19	SLR assembly	Stainless steel BS 970 303 S21
20	SLR gasket	Stainless steel BS 1449 304 S16
21	SLR seal	Graphite
28	Valve spring (DN25 only)	Stainless steel BS 2056 302 S26

* **Note:** Item 12 is pressed into item 1 (DN25 only).

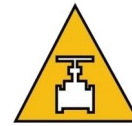

Capacities

CHRYSSAFIDIS

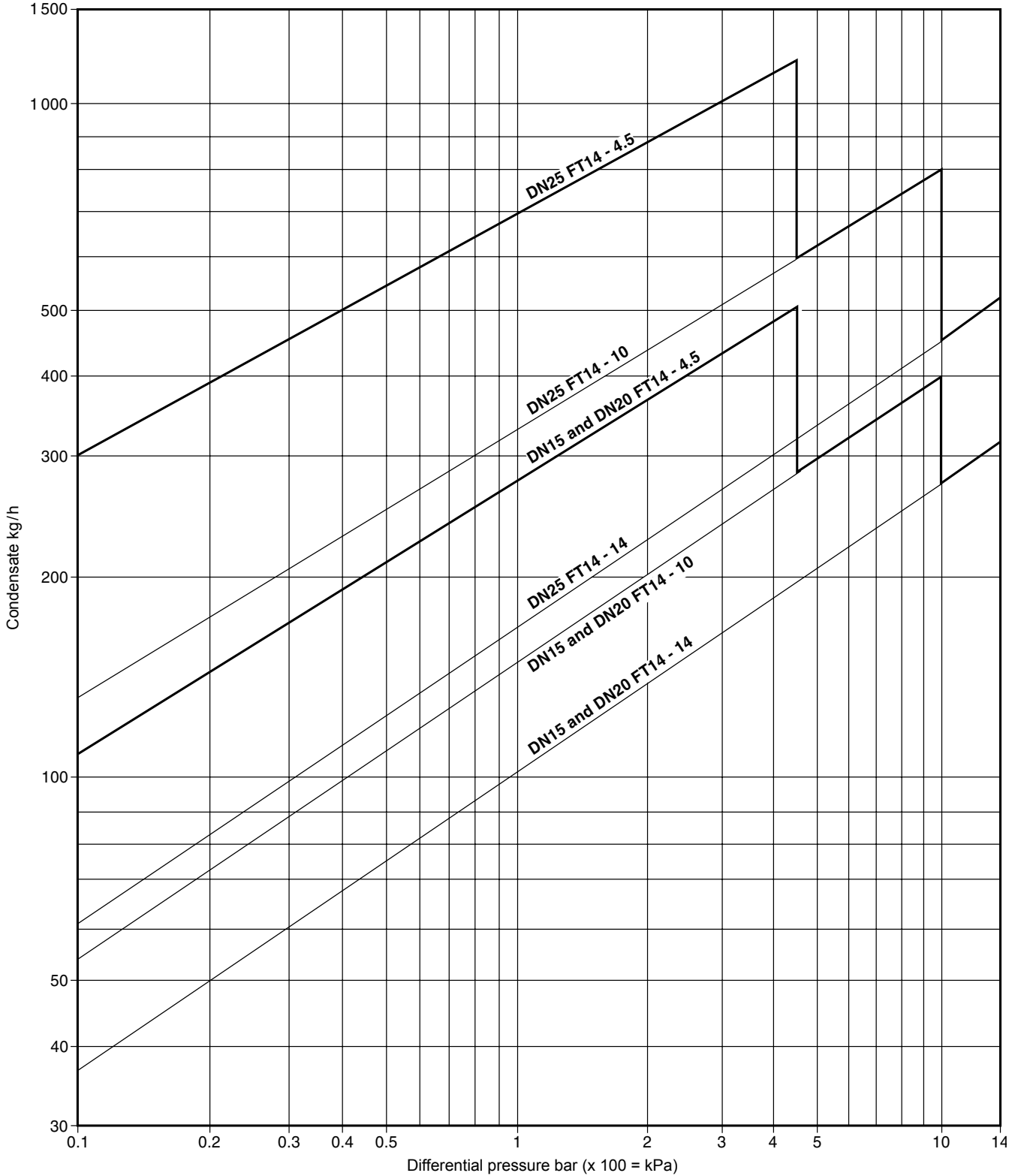

Capacities shown above are based on condensate at saturation temperature. When discharging sub-cooled condensate the air vent provides extra capacity. Under start-up conditions when the condensate is cold the internal thermostatic air vent will be open and provides additional capacity to the main valve. On 4.5 bar units this will provide a minimum of 50% increased capacity above the hot condensate figures shown. On 10 and 14 bar units this will be a minimum increase of 100% on the published capacity. The following table gives the minimum additional cold water capacities from the air vent.

ΔP (bar)	0.5	1	2	3	4.5	7	10	14
Minimum additional cold water capacity (kg/h)								
DN15 and DN20	70	140	250	380	560	870	1 130	1500
DN25	120	240	360	500	640	920	1 220	1500

Dimensions /weights (approximate) in mm and kg

Size	A PN/ASME	A JIS/KS	B	C	D	E	F	G Withdrawal distance	Weight
DN15	150	150	107	101	51	47	26.5	115	4.5
DN20	150	150	107	101	55	47	26.5	115	5.0
DN25	160	170	117	70	100	10	21.0	120	6.5

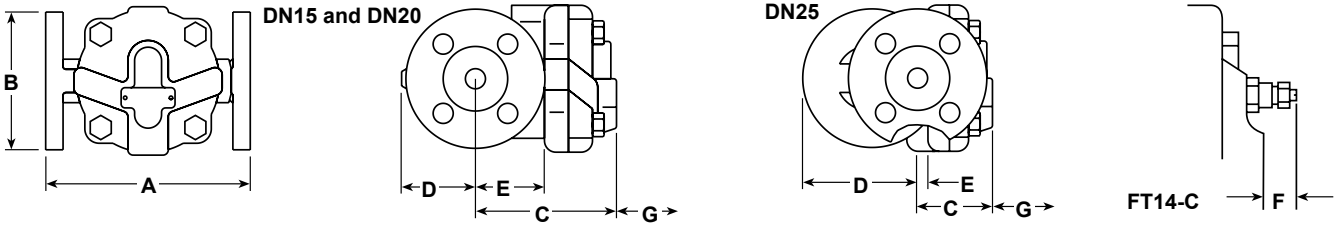

Safety information, installation and maintenance

For full details see the Installation and Maintenance Instructions (IM-S02-13) supplied with the product.

Installation note:

The FT14 must be installed with the direction of flow as indicated on the body, and with the float arm in a horizontal plain so that it rises and falls vertically. If required the flow orientation can be changed on site.

Disposal

This product is recyclable. No ecological hazard is anticipated with the disposal of this product providing due care is taken.

How to order

Example: 1 off Spirax Sarco DN25 FT14-4.5 (R-L) ball float steam trap with flanged PN16 connections and integral air vent.

Spare parts

The spare parts available are shown in solid outline. Parts drawn in broken line are not supplied as spares.

Available spares

Main valve assembly with float	3, 5, 6, 7 (2 off), 8, 10, 11, 28 (DN25 only)
Air vent assembly	3, 17, 18
Steam lock release and air vent assembly	3, 17, 18, 19, 20, 21
Cover gasket (packet of 3)	3
Maintenance kit	3, 5, 6, 7 (2 off), 8, 10, 11, 17, 18, 28 (DN25 only)

How to order spares

Always order spares by using the description given in the column headed 'Available spares' and state the size, type of trap and pressure range.

Example: 1 - Main valve assembly for a Spirax Sarco DN25 FT14-10 ball float steam trap.

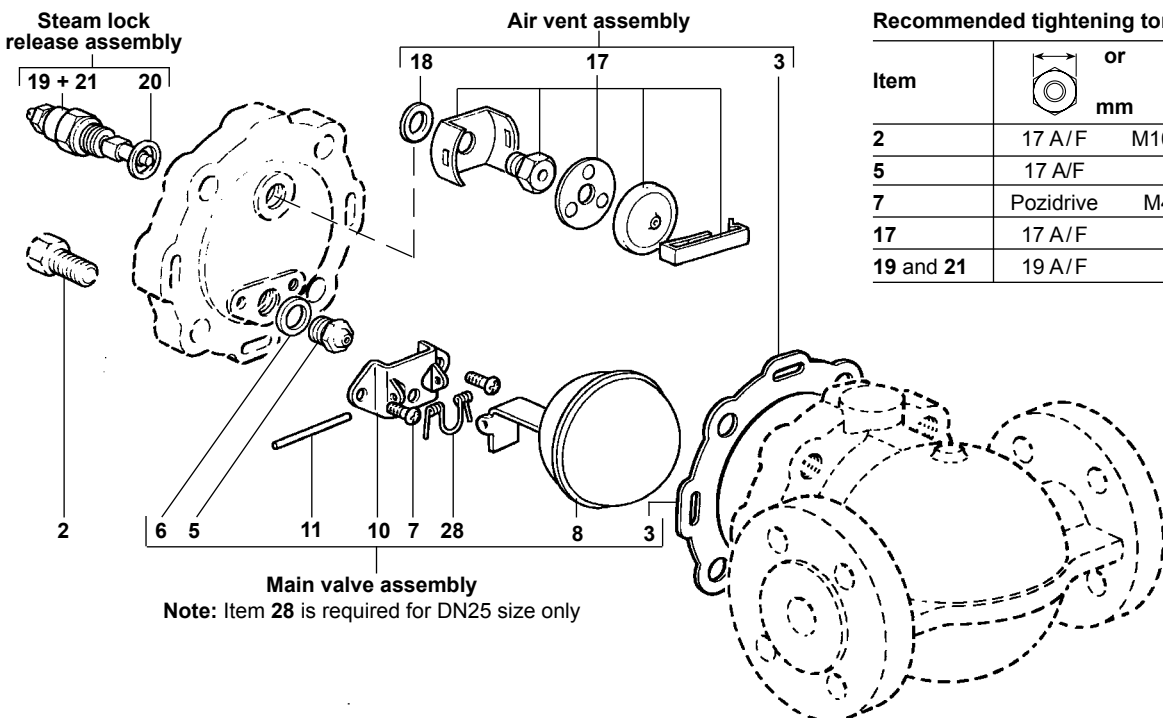

Recommended tightening torques

Item	or mm	N m
2	17 A/F M10 x 30	47 - 50
5	17 A/F	50 - 55
7	Pozidrive M4 x 6	2.5 - 3.0
17	17 A/F	50 - 55
19 and 21	19 A/F	50 - 55

